

FMR15101

1-Channel 151MHz Receiver

Features

- Single channel receiver with relay output
- Supply voltage can be 12 – 24 Volts AC or DC
- Low current consumption
- Built-in noise or signal strength indicator
- User can select 8 different frequencies
- Easy code setup with dip switch settings
- Momentary, latching, timed and security latching output modes can be selected by the user. Changing the settings on the four-way dip switch does this
- Optional QM100 bracket available for easy mounting to cases or walls. C1015 or C1020 case is also available

Applications

- Pump Control
- Long distance panic button
- On/Off applications in agricultural devices
- Security alarm
- Basic Telemetry eg. Water level indication

Description

This receiver gives you a single relay output with a contact rating of 8 amps at 240VAC. The relay mode can be set to momentary, latching, security latching, adjustable timed off delays or pulsing.

The user can select 8 different narrow band frequencies and program unlimited number of transmitters to the receiver. With a narrow band FM 151MHz signal from the transmitter a line of sight operating range of 5000 metres is possible. The receiver uses a crystal oscillator circuit that ensures high frequency stability allowing optimal performance in the receiving range.

Coding

The 12 way dip switch on the receiver sets the 12 bit unique code for the system. This has to be matched to that on the transmitter. **Do not use the factory default code.**

Apart from the 12 way dip switch there will be an additional dip switch depending upon the receiver type:

- Single channel receiver will have a 3 way dip switch.

This DIP switch on the right side of the 12 way dip switch denotes the channel. See table below.

Generally to use a 1 channel Tx to 1 channel Rx match all the 15 dip switch (12way + 3way just on the right side of the 12 way).

To use a multi channel Tx to control a number of (up to 8) Rx, refer to the table below for the switch setting.

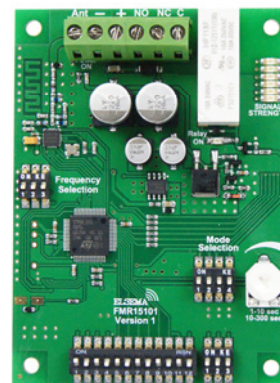









FMR15101

3-Way DIP Switch & Relay Output

SW13	SW14	SW15	Relay
OFF	OFF	OFF	Ch1
OFF	OFF	ON	Ch2
OFF	ON	OFF	Ch3
OFF	ON	ON	Ch4
ON	OFF	OFF	Ch5
ON	OFF	ON	Ch6
ON	ON	OFF	Ch7
ON	ON	ON	Ch8

Different Modes for the Output

Modes are user selectable from the 4-way dip switch, shown below.

	"Momentary": Relay on, only while correct signal is received
	"Latching": Relay alternates at every correct incoming signal
	"Delayed Off 1": Relay on, but delayed off for 1-10 seconds, adjustable by trimpot
	"Delayed Off 2": Relay on, but delayed off for 10-300 seconds, adjustable by trimpot
	"Pulsing": Relay will pulse at 1Hz for 10-300 seconds, adjustable by trimpot
	"Security latching On": Relay will energize until supply to receiver is momentarily interrupted
	"On-Off": This mode requires a 2-channel Tx. Channel 1 will always energize the relay Channel 2 will always de-energize the relay
	" Instant OFF " Same as " Delayed Off " except relay will switch "OFF" as soon as the transmitter input is deactivated
	"Test": Relay is energized, for test purpose only

Output Modes

Relay output on the receiver by default the mode is set to momentary. Other modes are selectable from the 4-way dipswitch.

Factory Default = Momentary

Momentary - Output is active for as long as the transmitter button is pressed.
This is a standard mode on most automatic gates or garage door openers.

Latching - Output remains active until next press of the transmitter button.
Similar to switching "on" and "off" a light.

Security Latching - Output remains active until power to the receiver is removed. Similar to security alarms and fire alarms.

Signal Strength Indicator

The 151MHz receivers have green signal strength LED's on the board. The table below indicates the level of the valid transmitted signal.

6 LED's on	-70dBm	Very Strong signal	Very Reliable operating conditions
5 LED's on	-75dBm	Very Strong signal	Very Reliable operating conditions
4 LED's on	-80dBm	Very Strong signal	Very Reliable operating conditions
3 LED's on	-90dBm	Strong signal	Very Reliable operating conditions
2 LED on	-100dBm	Good signal	Reliable operating conditions

Noise Strength Indicator

If more than 2 led is "ON" without a valid transmission, this indicates that there is noise on the frequency selected. Change the **3-way dipswitch** on the **receiver module** to select a different frequency. Following is a table with the Dipswitch settings and the corresponding frequencies.

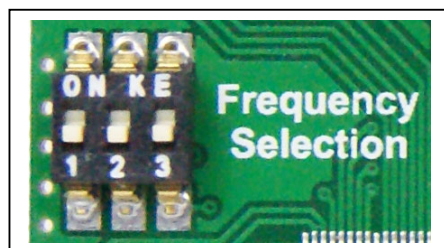





Frequency	1	2	3
151.600 MHz	On	On	On
152.375 MHz	Off	On	On
151.775 MHz	On	Off	On
151.400 MHz	Off	Off	On
151.175MHz	On	On	Off
151.025 MHz	Off	On	Off
150.900 MHz	On	Off	Off
150.825 MHz	Off	Off	Off

Technical Data

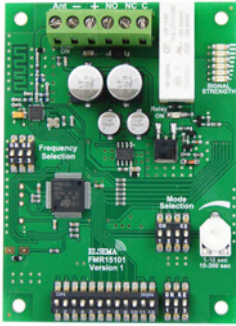
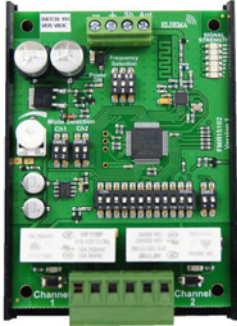
Supply Voltage	12 – 24 Volts AC or DC. Can use Elsema’s power pack (12PP-1000) Supply lines should be less than 3m long to comply with radio frequency authorities	
Current Consumption	24mA Standby at 12VDC	57mA when relay “ON” at 12VDC
Receiving Frequency	151.6MHz (8 selectable frequencies. See table above) 161MHz for New Zealand 154MHz for United States of America and Canada	
Operating Temperature Range	-5 to 50°C	
Outputs	One change over relay outputs, rated at 8 Amps 240VAC	
Relay Contacts	Common (C), Normally Closed (NC) & Normally Open (NO)	
Antenna	151MHz Antenna, Elsema ANT151M for maximum performance	
Dimensions	95 x 70 x 30mm	
Mounting Hole Size	3.97mm or 5/32”	
Useable Transmitters	All FMT151 series (with correct setting on the dip switch). See Transmitter datasheet for details	
Useable operating range	Up to 5000 metres, depending on installation and type of antenna used. Recommended Antenna is Elsema ANT151M	

Products in the Range

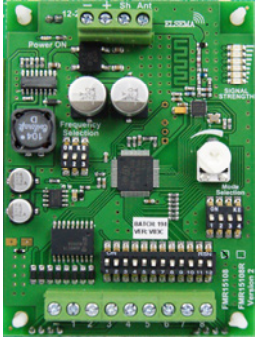
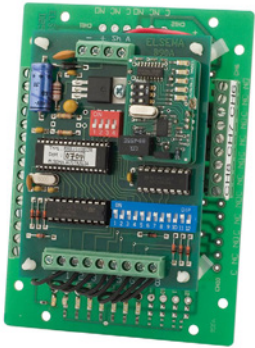
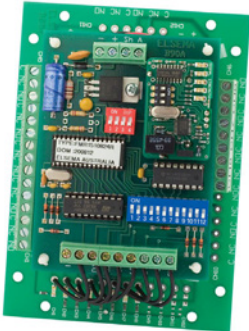
			
FMR15101 1-Channel	FMR15102 2-Channel	FMR15101240 1- Channel 240VAC Supply	FMR15102240 2- Channel 240VAC Supply
			
FMR15104 4-Channel	FMR15104240 4- Channel 240VAC Supply	FMR15108 8-Channel	FMR1510812R 8-Channel, 12V Supply
			
FMR1510824R 8-Channel, 24V Supply			

Block Diagram

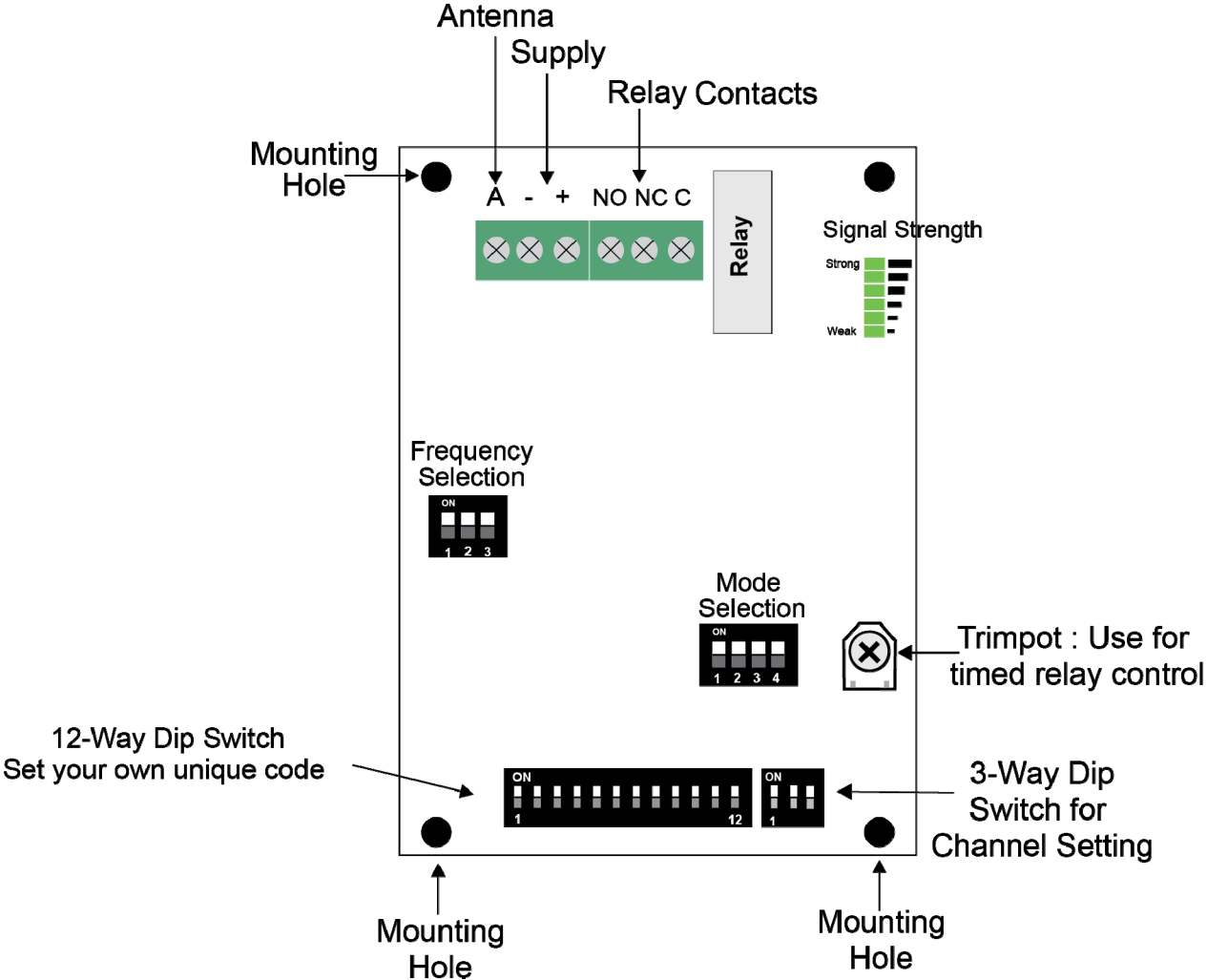

FMR15101 12/24 VAC/DC Application

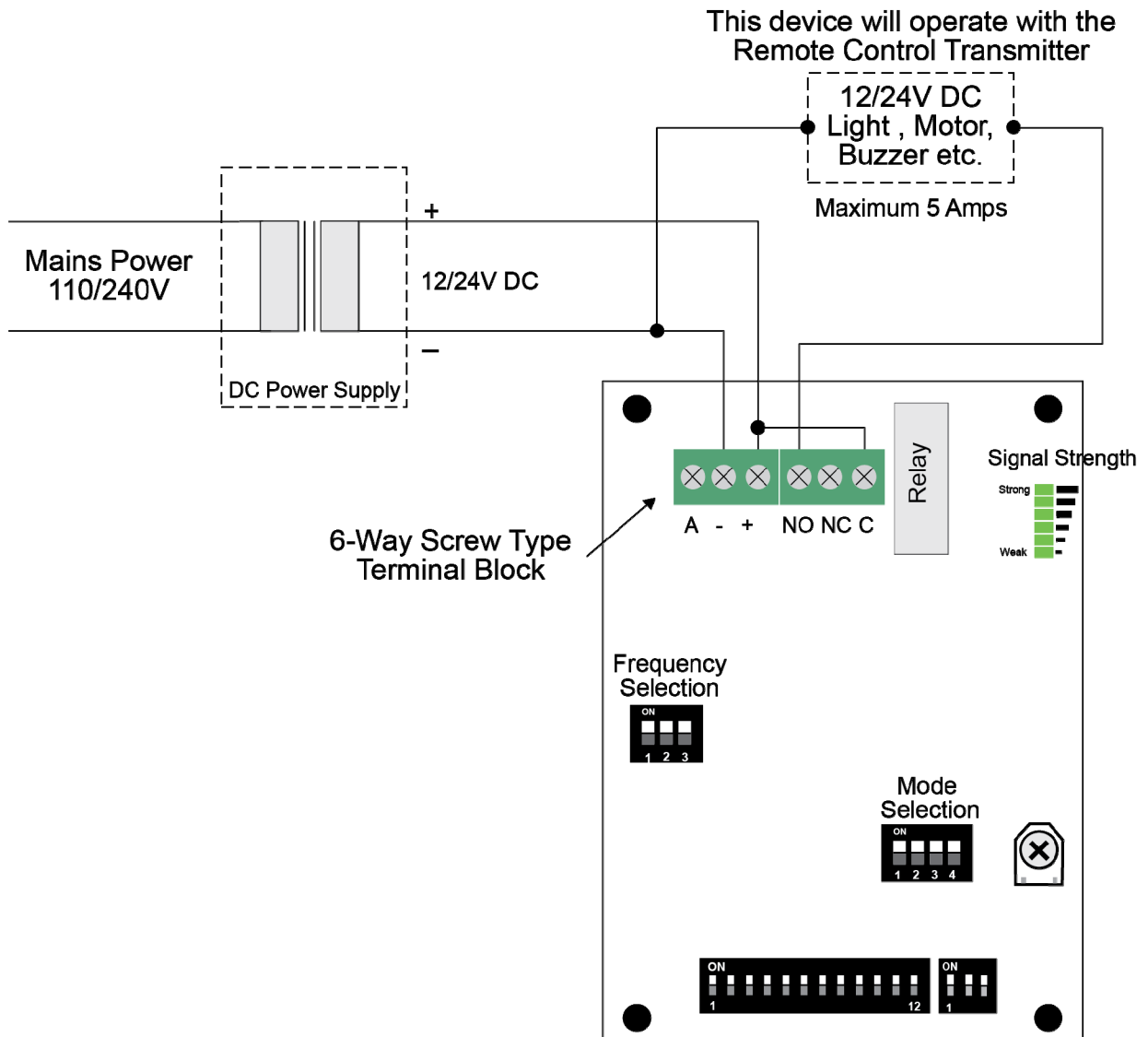

FMR15101 110/240 VAC Application

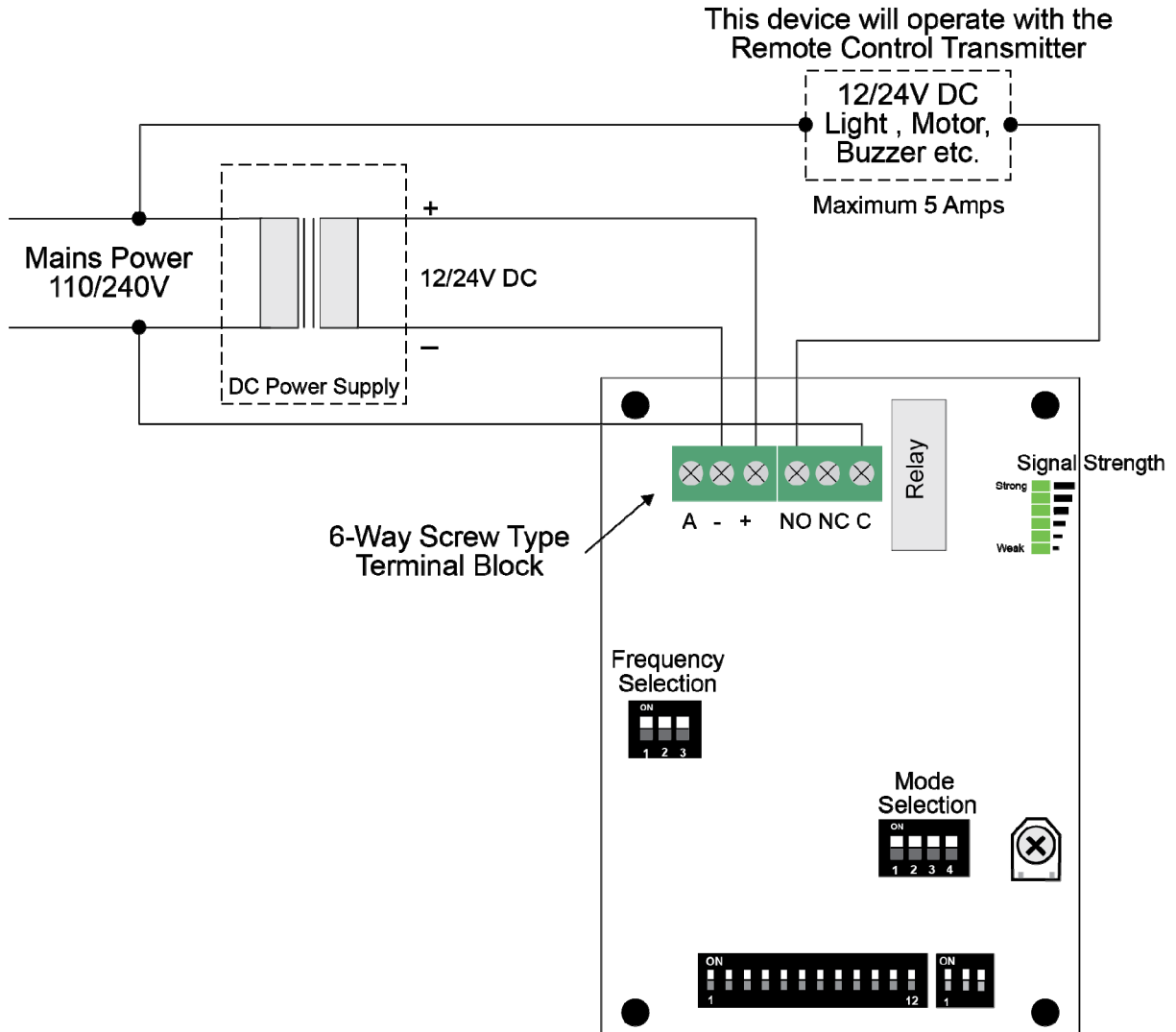

Manufactured by

Elsema Pty Ltd
 31 Tarlington Place, Smithfield
 NSW 2164, Australia.
 Ph: 02 9609 4668
 Website: <http://www.elsema.com>

Distributed by: