

PASSIVE INFRARED SENSOR

PA-470L WIDE ANGLE / LONG RANGE

PA-480S SUPER WIDE ANGLE



OPTIONAL : ATTACHMENT BCW-401

NEW GENERATION WALL MOUNT PASSIVE INFRARED SENSOR

PA-470L FEATURES

QUAD ELEMENT+ NEW FUZZY LOGIC PROCESSING SYSTEM

"Fuzzy Logic" is the state-of-the-art processing system that simulates the human decision process as it compares various information such as size, temperature differential, etc. to determine the criteria for an alarm condition. This reduces false alarm while maintaining a high detection capability.

PATTERN SELECTABLE WITH INTERCHANGEABLE LENS

Wide angle / long range pattern is selectable during installation by convenient fresnel lens replacement. Spare long range lens is included in package. Zone changeover switch sets the detection pattern to match the lens pattern when lens is changed.

TROUBLE ALARM -LOW VOLTAGE-

When sensor detects a drop in supply voltage, the alarm relay and LED latches in alarm until voltage is restored to its proper level.

ALARM MEMORY

Units contain special circuitry to indicate that an alarm has been activated during armed period. Especially useful when more than one unit is used per zone.

REMOTE LED CONTROL

Enables/disables the LED via the control panel.

- *Alarm LED selectable (ON/OFF)
- *Alarm contact selectable (N.C./N.O.)
- *Sensitivity adjustment (60%,80%,100%,120%)
- *Zone changeover (Wide angle/long range)
- *Anti-creep zone

PA-480S FEATURES

WALL MOUNT 180° COVERAGE

Two twin elements cover 90° each to create a full 180° pattern. Each 90° area can be vertically adjusted up or down to create the required coverage pattern.

TROUBLE ALARM -LOW VOLTAGE-

When sensor detects a drop in supply voltage, a trouble alarm is output.

- *Alarm LED selectable (ON/OFF)
- *Signal count selectable (2 signals / 4 signals)
- *Anti-creep zone

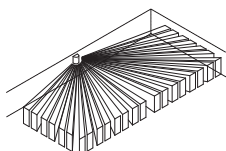

One unit covers two units' area

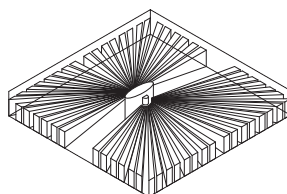

When installed on central pillar, 2 units cover 360° pattern

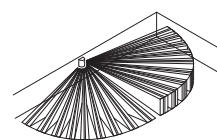

Different coverage by 90° each

PASSIVE INFRARED SENSOR

COVERAGE

PA-470L

TOP VIEW / WIDE ANGLE

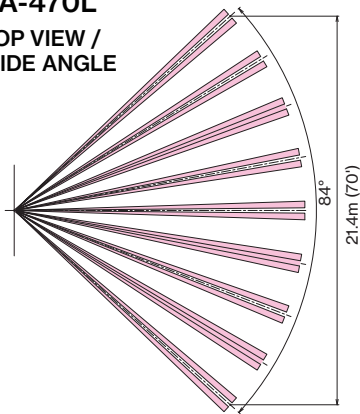

TOP VIEW / LONG RANGE



SIDE VIEW / WIDE ANGLE

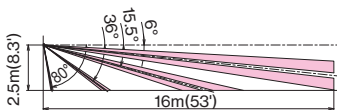

SIDE VIEW / LONG RANGE

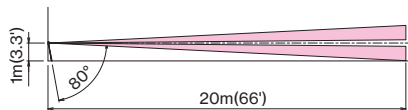

PA-480S

TOP VIEW / WIDE ANGLE

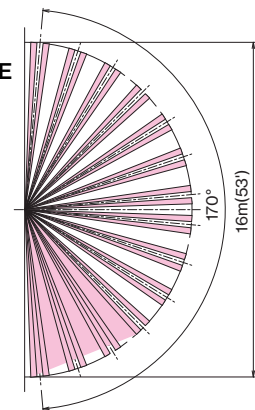

SIDE VIEW / SUPER WIDE ANGLE

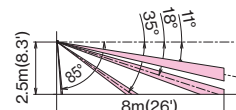

TERMINAL ARRANGEMENT

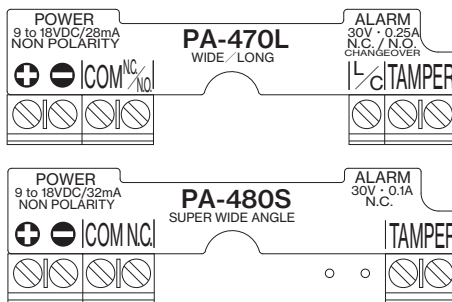

EXTERNAL DIMENSIONS

[Unit : mm (inch)]

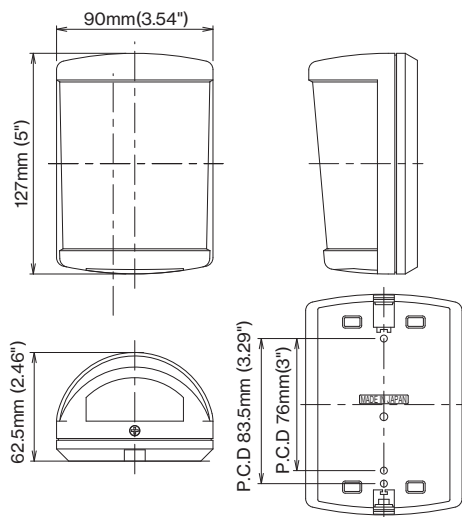

SPECIFICATIONS

Model	PA-470L	PA-480S
Detection	Passive infrared (Quad · Fuzzy logic)	Passive infrared (Twin element · pulse count)
Coverage	Wide angle 16m(53') Max Long range 20m(66') Max	Super wide angle radius 8m(26') Max
Number of sensitive zone	22 pairs (88)	2 pairs (8) 32 pairs (64)
Mounting positions	Indoor wall / pillar	
Supply voltage	9.5 to 28 VDC (non-polarity)	
Power consumption	25mA Max.	20mA Max.
Alarm output	Dry contact relay (N.C./N.O. selectable) Reset : approx. 2sec. 30VDC (24VAC) · 0.25A Max (protective resistance 3.3 Ω built-in)	Dry contact relay (N.C.) Reset : approx. 2 sec. 30VDC (24VAC) · 0.1A Max (protective resistance 3.3 Ω built-in)
Temper output	Dry contact (N.C.) Open when cover is detached 30V · 0.1A Max	
Alarm LED	Red LED Warm up : flickering (every 0.5 sec.) Alarm : solid (approx. 2 sec.) Memory : continuous solid Trouble alarm : continuous solid (LED disable)	Red LED(2) Warm up : flickering (every 0.5 sec.) Alarm : solid (approx. 2 sec.) Trouble alarm : continuous solid (LED disable)
Alarm memory	Flickering : Memory activated Lighting : Memory indication	
LED control	Controls alarm LED indication with terminal L/C	
Trouble alarm	Low power voltage : monitors drop in power voltage Operate : initiate trouble alarm	
Ambient temp. range	-10°C to +50°C(+14°F to +122°F) without condensation	
Wiring	Terminals	
Area adjustment	Downward 5 positions	
Weight	5.8oz. (165g)	
Accessory	Fixing screw : 4 × 30 2pcs. Long range lens	Fixing screw : 4×30 2pcs. Area lock screw : 3×10 1pc.

The passive infrared sensor is designed to detect infrared energy variations caused by the presence of a human body. Therefore, note that similar variations in conditions in protected area, due to other reasons, may cause the sensor to create an alarm as it is unable to distinguish between sources.

* The specifications are subject to change without notice.

Please note : This sensor is designed to detect intrusion and to initiate an alarm; it is not a burglary or a crime preventing device. TAKEX is not responsible for damage, injury or losses caused by accident, theft, Acts of God (including inductive surge by lightning), abuse, misuse, abnormal usage, faulty installation or improper maintenance.

TAKEX

In Japan

Takenaka Engineering Co., Ltd.
83-1, Gojo-Dori, Sotokan Nishi-iru, Higashino,
Yamashina-ku, Kyoto 607-8156, Japan
Tel : 81-75-501-6651

<https://www.takex-eng.co.jp/>

In the U.S.

Takex America Inc.
1810 Oakland Rd, Suite F,
San Jose, CA 95131, USA
TEL : 408-747-0100
FAX : 408-734-1100

<https://www.takex.com>

In Australia

Takex America Inc.
4/15 Howleys Road, NottingHill,
VIC,3168
Tel : +61 (03) 9544-2477
Fax : +61 (03) 9543-2342

<https://www.takex.com>

In the U.K.

Takex Europe Ltd.
Aviary Court, Wade Road,
Basingstoke, Hampshire. RG24 8PE, U.K.
Tel : (+44) 01256-475555
Fax : (+44) 01256-466268

<https://www.takex.com>